

TYPICAL 'D-320' PLAN VIEW

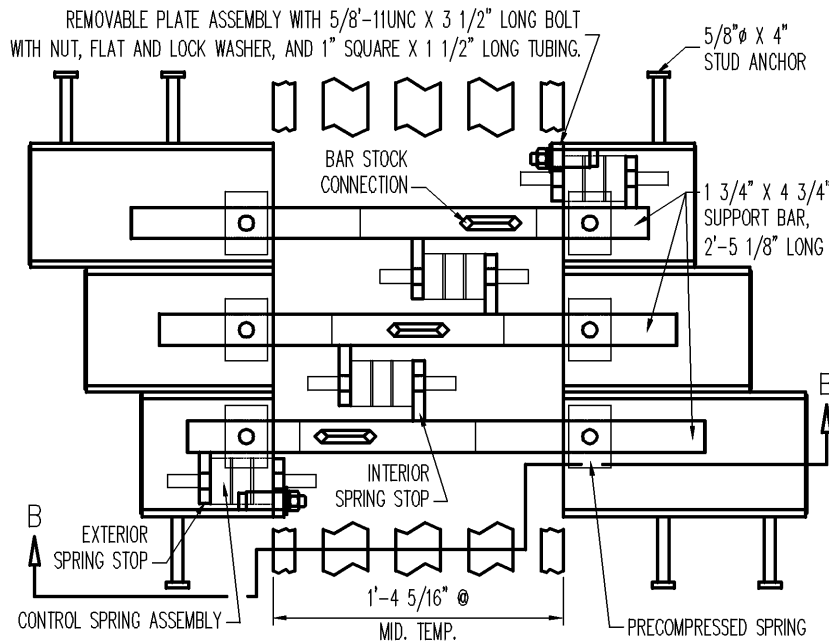

DETAIL "A" - PLAN VIEW OF 'D-320' EXPANSION JOINT @ SUPPORT BOX

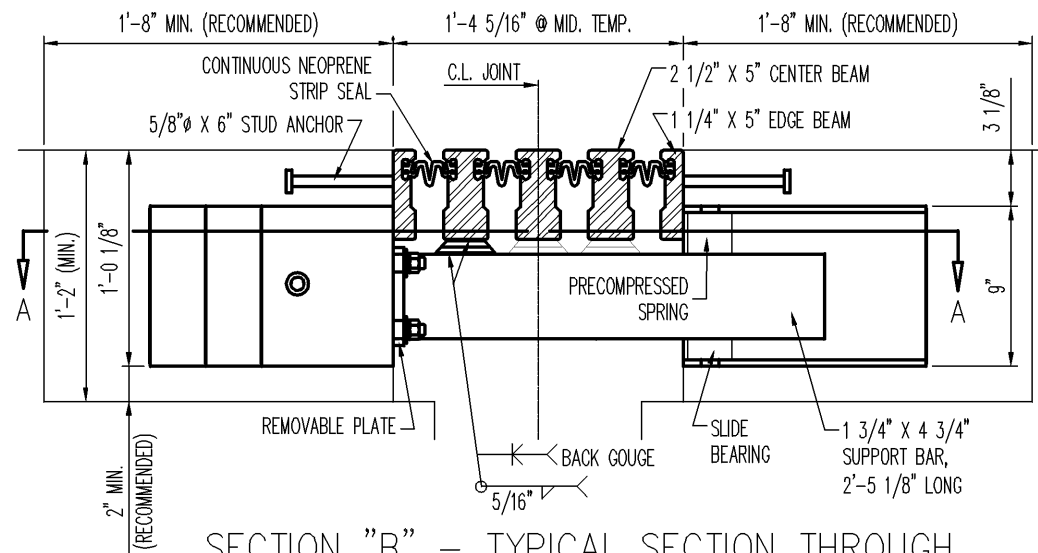

SECTION "B" - TYPICAL SECTION THROUGH 'D-320' EXPANSION JOINT @ SUPPORT BOX

NOTE: ALL DIMENSIONS SHOWN ARE BASED ON A 0° SKEW.

ALL FABRICATED COMPONENTS SHALL BE GALVANIZED IN ACCORDANCE WITH ASTM A123.

DS BROWN STANDARD DETAILS FOR STEELFLEX 'D-320' MODULAR EXPANSION JOINT ASSEMBLY

SCALE: N.T.S.	DRAWN BY: BLB	CHECKED BY: -	DATE: 1/4/06	DRAWING NUMBER 1 OF 1
FOLDER: MODULAR STANDARD DRAWINGS			REVISION:	SHEET D320-PV-S

